



LOCALE

MAGAZINE

Living like a local

MEDIA KIT 2024

localemagazine.com.au

Living like a local

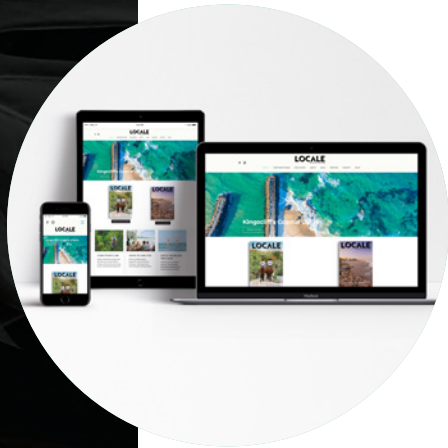

- Locale Magazine is dedicated to promoting businesses and attractions in the Gold Coast and Northern Rivers regions.
- Our premier 68-page quarterly magazines cover local fashion, dining, living, arts, entertainment, lifestyle, and beauty.
- Our team of creative locals is passionate about highlighting the wonderful aspects of these regions and communities.
- We distribute 7,000 printed copies throughout the Gold Coast and 5,000 printed copies throughout the Northern Rivers in various establishments such as resorts, Airbnbs, hotels, cafes, restaurants, and fashion boutiques.
- Multiple booking discounts are available to help businesses maximize their exposure.
- In addition to our print editions, Locale Magazine has a rapidly growing online presence.
- When you advertise with us, your business receives dedicated social media posts across our platforms, including Instagram.
- Our social media profiles drive traffic to our website and promote our advertisers, events, and services.



SALES AND ADVERTISING ENQUIRIES

- ✉ sales@localemagazine.com.au
- ☎ 0413 459 410
- 📷 [locale_magazine](#)
- 📘 [localemagazineau](#)

DEMOGRAPHICS



FREQUENCY
QUARTERLY



PRINT COPIES
7,000+ GC
5,000 + NR



DEMOGRAPHIC
25-70YOs



LOCATION
GOLD COAST
NORTHERN RIVERS



EMAIL
SUBSCRIBERS
4,000+



ONLINE
READERSHIP
5,000+



SOCIAL MEDIA
6,000+



DISTRIBUTION
GOLD COAST
NORTHERN RIVERS



MAGAZINE PAID
SUBSCRIBERS
181



ONLINE READS
PER MONTH
2110+



AVERAGE
TIME READ
26min



DWELL TIME
PER ARTICLE
1:54min

DEADLINES 2024

EDITION	BOOKING DEADLINES	MATERIAL DEADLINE	DISTRIBUTION
AUTUMN '24	10th February	20th February	11th March
WINTER '24	6th May	18th May	3rd June
SPRING '24	16th August	16th August	2nd September
SUMMER '24	4th November	18th November	1st December

ARTWORK

- Print artwork to be supplied as Press Ready PDF, using CMYK colours
- Images must be minimum 300dpi
- Complete material supplied as press quality pdf (300 dpi)
- Photography, copy writing, design and layout fees on application
- Proof supplied in PDF format, changes and approvals required by email
- Advertisers are responsible for accuracy on proofing.

Design support

Need help with your artwork? We have a full design service to help develop your advertisement for an additional fee. Always here to help locals!

ADVERTISING RATES (One edition only, GC or NR)

RATES PER QUARTER

15% PREMIUM POSITION LOADING FEES APPLY. 10% GST APPLIES ON ALL PRICES

AD SIZE	CASUAL per quarter	x 2 per quarter	x3 per quarter	x4 per quarter
Full page	\$1,650	\$1,495	\$1,355	\$1,230
Half page	\$890	\$810	\$740	\$675
Quarter Page	\$580	\$535	\$490	\$450
Inside FC / BC	\$2,090	\$1,890	\$1,710	\$1,650
DPS	\$2,800	\$2,530	\$2,380	\$2,060
Back cover	\$2,200	\$1,990	\$1,800	\$1,630
Double page advertorial	(upto 800 words)		\$1,890	
Full page editorial	(upto 500 words)		\$1,000	
1/2 page editorial	(300 words)		\$500	
<small>(only available with addition of a half page advert)</small>				
Editorial inclusion	(upto 150 words)		\$150	
Product Placement	\$150/product			

PAYMENT & CANCELLATION TERMS:

Total cost per issue to be paid as follows:

· On contract, full payment. · With proof approval, full payment total cost. · Cancellations after the booking deadline will be charged at full rate. · Written cancellations accepted seven days prior to booking deadline.

ADVERTISING RATES

CROSS PROMOTION NORTHERN RIVERS & GOLD COAST EDITIONS (2 ISSUES)

Take advantage of our cross-promotion advertising rate, meticulously crafted to amplify your brand exposure and awareness. By showcasing your brand in both the Northern Rivers and Gold Coast editions, you'll harness the power of double exposure, effectively reaching a broader audience. This exclusive opportunity is tailored to enhance your brand visibility significantly and foster a robust presence in the market.

RATES PER QUARTER

15% PREMIUM POSITION LOADING FEES APPLY. 10% GST APPLIES ON ALL PRICES

AD SIZE	CASUAL per quarter	x 2 per quarter	x3 per quarter	x4 per quarter
Full page	\$2,900	\$2,600	\$2,340	\$2,110
Half page	\$1,600	\$1,400	\$1,260	\$1,135
Quarter Page	\$1,000	\$890	\$810	\$730
Inside FC / BC	\$3,600	\$3,300	\$2,970	\$2,675
DPS	\$4,700	\$4,250	\$3,825	\$3,445
Back cover	\$3,850	\$3,450	\$3,150	\$2,860

PAYMENT & CANCELLATION TERMS:

Total cost per issue to be paid as follows:

- On contract, full payment.
- With proof approval, full payment total cost.
- Cancellations after the booking deadline will be charged at full rate.
- Written cancellations accepted seven days prior to booking deadline.

PAGE SPECS

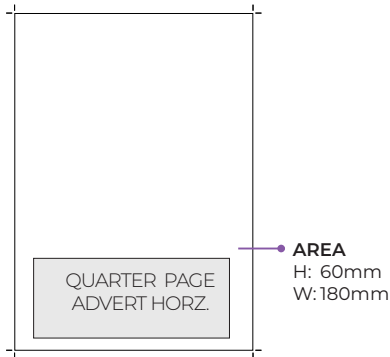
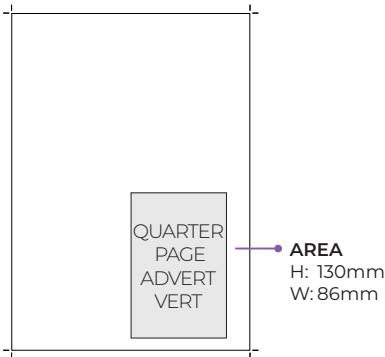
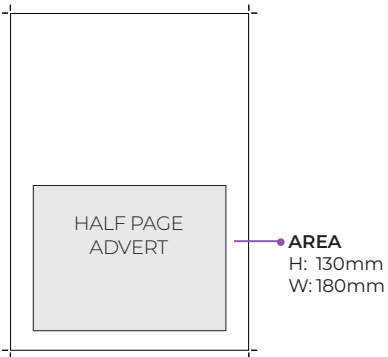
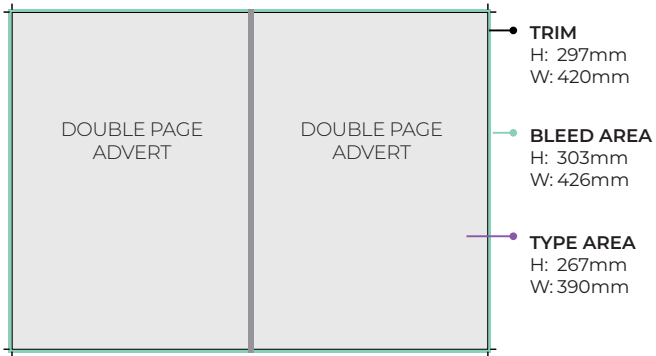
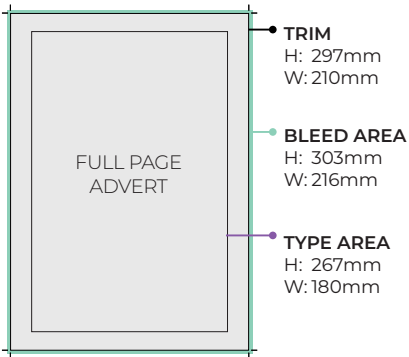





LOCALE
MAGAZINE

Living like a local

FOLLOW US

 [locale_magazine](https://www.instagram.com/locale_magazine)

 [localemagazineau](https://www.facebook.com/localemagazineau)

[localemagazine.com.au](https://www.localemagazine.com.au)